

Al/Cl₂ battery with slightly acidic NaCl electrolyte.

I. Porous graphite chlorine cathodes

J.-F. EQUEY, S. MÜLLER, A. TSUKADA, O. HAAS

Paul Scherrer Institute, CH-5303 Würenlingen, Switzerland

Received 4 January 1988; revised 21 June 1988

Al/Cl₂ cells were built using a coaxial cylindrical cell arrangement with cylindrical porous graphite chlorine electrodes and 99.5% Al anodes (cylindrical rods). The electrolyte used was a slightly acidic aqueous NaCl solution containing small amounts of In³⁺ and Hg²⁺ as additives. The cells have an open-circuit voltage of 2.6 V and a maximum power density of 55 mW cm⁻² at a cell voltage of 1.6 V with a Faradaic efficiency of 65-70%. A battery consisting of seven cells connected in parallel delivered a maximum power of about 15 W.

1. Introduction

The high energy density (31 MJ kg⁻¹), the excellent storability and transportability and the rather low price are properties which promote aluminum as an energy storage medium and especially as an anode material in electrochemical energy conversion devices [1]. In aqueous electrolytes, aluminum electrodes can only be used for primary batteries or fuel cell systems. In this context Al/air cells are probably the most attractive and also the most highly developed systems. For the Al/air cells most of the work has been done with strongly alkaline electrolyte [2-7] or in neutral NaCl solutions [8-10]. Due to the good performance of chlorine-reducing electrodes in Zn/Cl₂ batteries [11-14] and to the fact that aluminum chloride is readily soluble in weakly acidic electrolytes, we investigated Al/Cl₂ cells using weakly acidic NaCl solutions as an electrolyte. In a previous paper [15], we showed that the electrochemistry of aluminum can be improved considerably when In³⁺ + Zn²⁺ or In³⁺ + Hg²⁺ are added in small amounts to a weakly acidic NaCl solution. These additives modify the aluminum surface and shift the anodic dissolution to more negative potentials [16, 17]. With In³⁺ and Hg²⁺ as additives, the open-circuit potential rises to 2.6 V.

In this paper we describe the performance of a single Al/Cl₂ cell with coaxial cylindrical electrode arrangement and some results of a module consisting of seven cells connected in parallel are described. Porous graphite was used as a material for the cylindrical Cl₂ electrodes.

2. Experimental details

2.1. Materials

2.1.1. Cathodes. Porous graphite PG60 (Union Carbide) was used after soaking for a week in conc.

HNO₃ and washing carefully with deionized water. Cl₂ (> 99.9%, Fluka) was used as received.

2.1.2. Anodes. Al (99.5%) wires (ϕ 0.5 cm) from Alesa AG were used as received.

2.1.3. Electrolyte. Aqueous 2 M NaCl solution containing 3×10^{-4} M InCl₃ and 3×10^{-4} M HgCl₂ at pH 2 was used as an electrolyte. The pH was adjusted by addition of HCl to the solution. NaCl (puriss, Siegfried), InCl₃ (95%, Fluka) and HgCl₂ (puriss, Fluka) were used as received.

2.2. Apparatus

The current-potential curves were recorded using an Amel Model 555B potentiostat, an Amel Model 568 function generator and a Linseis LY1800 x-y recorder. A saturated calomel reference electrode (SCE) with an agar-filled capillary was inserted between the two electrodes to make potentiostatic measurements.

The cell voltages and the corresponding cell currents obtained while using different working resistance were recorded by an Olivetti PC M24.

2.3. Cell design

The cylindrical porous graphite electrode (ϕ_{inner} : 1.65 cm, ϕ_{outer} : 2.0 cm, l_{active} : 15.5 cm) (Fig. 1, 1) used as chlorine cathode and the Al rod (ϕ : 0.5 cm) (Fig. 1, 2) used as an anode, were arranged concentrically to form a unit cell. Six of these units, arranged hexagonally around a seventh central unit, were inserted vertically in a plexiglas cylinder (ϕ : 12 cm) (Fig. 1, 6), which served as a case for this battery module. The plexiglas was very resistant against chlorine and electrolyte as long as the solution was not too acidic. The electrolyte was circulated by pumping through the porous graphite electrodes via the horizontal inlet (Fig. 1, 7) in the middle of the plexiglas cylinder. It was then collected at the top and bottom part of the cell via the outlets

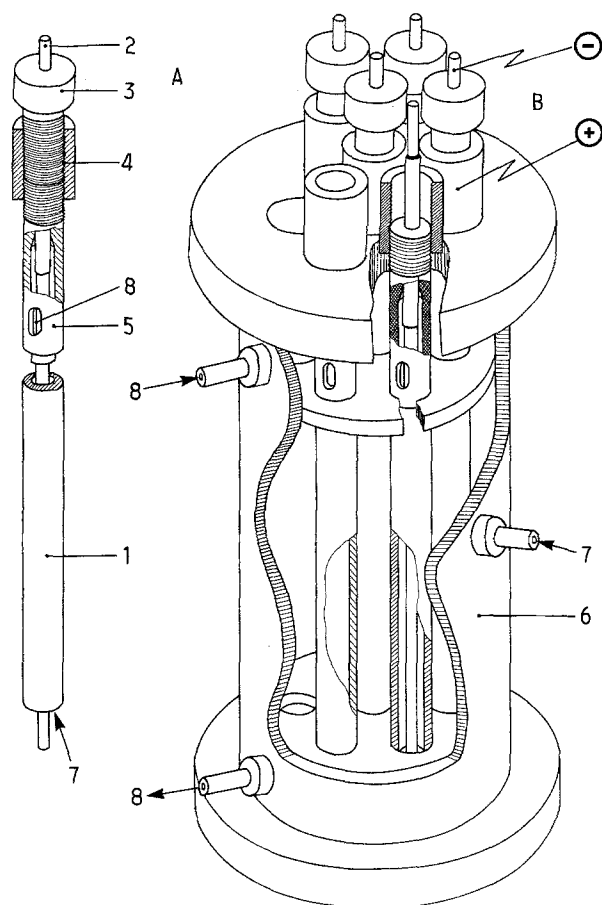

Fig. 1. (A) Unit cell: (1) porous graphite chlorine cathode (ϕ_{inner} : 1.65 cm, ϕ_{outer} : 2.0 cm; active length: 15.5 cm); (2) Al anode rod (ϕ : 0.5 cm); (3) Teflon[®] screw; (4) brass head; (5) dense graphite glued onto (1). (B) Module of seven Al/Cl₂ cells arranged hexagonally around a central cell in a polymethyl methacrylate (plexiglas) cylinder (6); (7) inlet hole; (8) outlet hole.

(Fig. 1, 8a and 8b). In order to avoid leakage, every critical joint was sealed with an O-ring. Each anode was centered inside the cathode tube by a plexiglas bed-plate at the bottom and a piece of Teflon[®] (Fig. 1, 3) screwed on the brass head (Fig. 1, 4) at the top. The anodes were contacted at the top of the aluminum rods by screwing on a copper lead. To contact the porous active cathode (Fig. 1, 1), a dense graphite tube (Fig. 1, 5) was glued with a graphite glue on the porous electrode (part 1) and a brass head was screwed in to this part as a current collector. The active electrode area was 80 cm² for each cathode and 25 cm² for the anodes. The battery module had a total active cathode area of 560 cm² and an anode area of 175 cm². The seven unit cells were electrically connected in parallel. The electrolyte circulation through the battery module was performed by an external pump between a 3-l electrolyte tank and the module. The pumping rate was about 3 ml min⁻¹ cm⁻². The solution was continuously saturated with chlorine in the electrolyte reservoir and the hydrogen produced was continuously eliminated via a bubble trap mentioned below.

2.4. Faradaic efficiency and hydrogen evolution rate

The Faradaic efficiency was measured by comparing

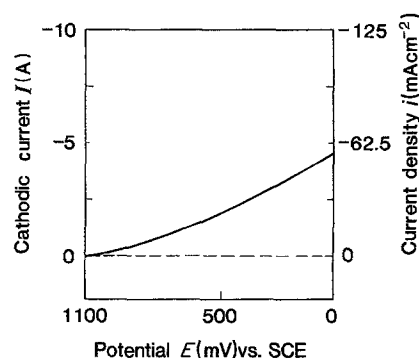

Fig. 2. Current-potential curve vs SCE (sweep rate = 10 mV s⁻¹) for the Cl₂ electrode (porous graphite tube). Cl₂ electrode surface area: 80 cm². Electrolyte: 2 mM NaCl + 3 × 10⁻⁴ M InCl₃ + 3 × 10⁻⁴ M HgCl₂; pH 2.

the weight loss of the aluminum electrode with the coulombs produced by the cell. Measurements were performed over a period of 4 h. To distinguish between losses produced by hydrogen evolution and chlorine corrosion, the gas developed in the cell was collected using a bubble separator and a gas burette in the external electrolyte circulation. The chlorine content of the gas was eliminated by washing it with a 4 M NaOH solution. The cleaned hydrogen was then measured volumetrically by taking into account its partial water pressure.

3. Results and discussion

The electrochemical behaviour of both the Al and the Cl₂ electrodes were studied by measuring the current-potential curves (Figs 2 and 3). The electrolyte used for these measurements was an aqueous 2 M NaCl solution containing 3 × 10⁻⁴ M HgCl₂ and 3 × 10⁻⁴ M InCl₃ at pH 2.

In Fig. 2, the current-potential curve of the chlorine electrode shows that the cathodic current starts at +1070 mV (SCE) and reaches a current density of 32 mA cm⁻² at an overpotential of 700 mV. The anodic current of the Al electrode starts at -1630 mV vs SCE (Fig. 3) and reaches the same current density as the chlorine electrode at a much lower overpotential (280 mV). The power output of the cell therefore is

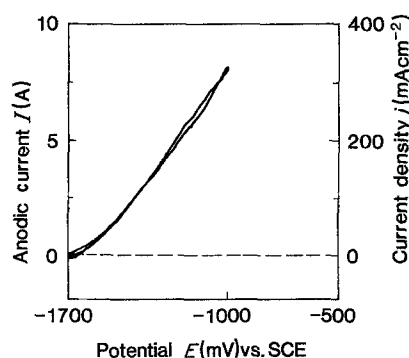

Fig. 3. Current-potential curve for an anodic and a cathodic sweep between -1700 and -1000 mV vs SCE (sweep rate = 10 mV s⁻¹) using an Al electrode (99.5%) in a single-unit cell (as depicted in Fig. 1A). Al electrode surface area: 25 cm². Electrolyte: 2 M NaCl + 3 × 10⁻⁴ M InCl₃ + 3 × 10⁻⁴ M HgCl₂; pH 2.

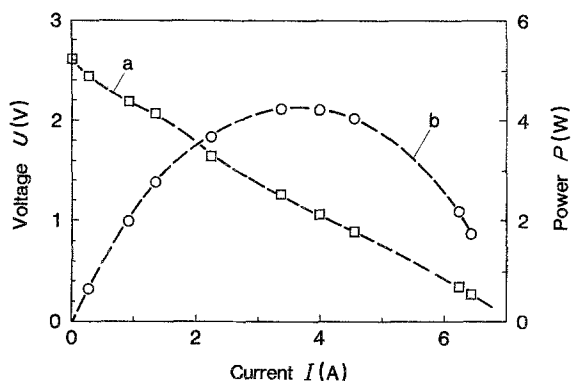

Fig. 4. Voltage and power vs current measured on a single cell. Al electrode surface area: 25 cm²; Cl₂ electrode surface area: 80 cm². Electrolyte: 2 M NaCl + 3 × 10⁻⁴ M InCl₃ + 3 × 10⁻⁴ M HgCl₂; pH 2.

mainly limited by the chlorine electrode. From these measurements, the expected open-circuit voltage of this Al/Cl₂ cell is 2.7 V.

The voltage and the power delivered by the cell are plotted as a function of current in Fig. 4 (a and b). Each point was recorded after the cell had been delivering current for 15 min to measure invariant power outputs on a given external resistance.

Figure 4 shows results for a single cell. The maximum power (4.2 W) was obtained at a current of 3.5 A and a voltage of 1.2 V. The maximum power density was 55 mW cm⁻² and the corresponding current density 40 mA cm⁻². The maximum current density reached was 80 mA cm⁻². These densities refer to the Cl₂ electrode area.

Figure 5 shows the time dependence of cell voltage and cell current as well as the development of the parasitic hydrogen evolution. After a short induction period the cell showed a very stable cell voltage and only small current fluctuation. The hydrogen production however was continuously increasing. The hydrogen production was measured volumetrically after washing the gas with an alkaline solution to eliminate the chlorine content. The reason for the transition period is not known exactly, but it is probably due to the fact that the Al electrode was not pretreated with a solution containing Hg²⁺ and In³⁺.

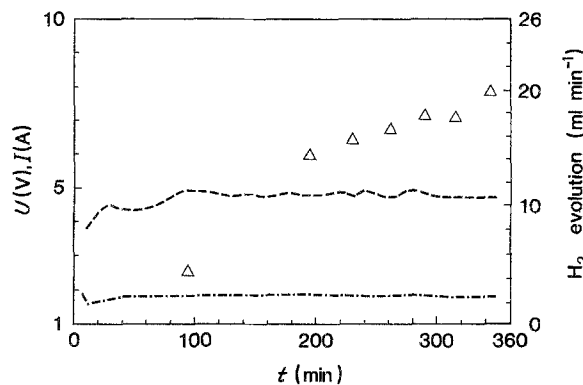

Fig. 5. (a) Current-time and (b) voltage-time curves for a single Al/Cl₂ cell (as depicted in Fig. 1). Time dependence of the rate of hydrogen production in ml min⁻¹. Electrolyte: 2 M NaCl + 3 × 10⁻⁴ M InCl₃ + 3 × 10⁻⁴ M HgCl₂; pH 2. (---) *I*; (-·-·-) *U*; (△△△) H₂ evolution.

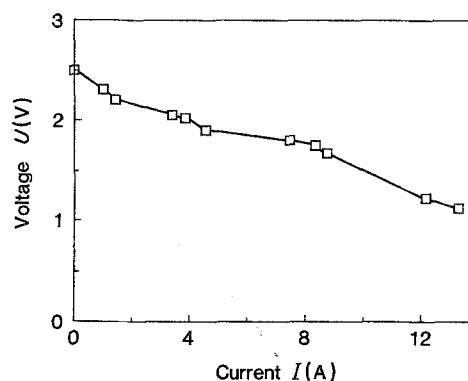

Fig. 6. Voltage-current characteristics for the module depicted in Fig. 1. Electrolyte: 2 M NaCl + 3 × 10⁻⁴ M InCl₃ + 3 × 10⁻⁴ M HgCl₂; pH 2.

The modification of the Al surface with these elements is not spontaneous. This and the fact that the electrolyte was probably not completely saturated to start with may account for this induction period. In the presence of the additives mentioned above, the passivation of the Al electrode does not play an important role, as can be seen from Fig. 3 where the current-potential curves show no hysteresis between the anodic and cathodic sweep.

The performance of the whole module as depicted in Fig. 1 with seven cells connected in parallel, is illustrated in Fig. 6. The open-circuit potential was 2.55 V. The slope of the current-voltage curve indicated an internal resistance of about 100 mΩ. The maximum power was 15 W at a cell voltage of 1.75 V which corresponds to a maximum power density of 26 mW cm⁻² when referring to the area of the Cl₂ electrodes.

The stability of the power delivered by the module working with four different external resistances is depicted in Fig. 7. It shows that after the induction period, the power did not change by more than 5%. The final concentration of Al³⁺ was ca. 0.15 M (31 of solution). The current decreased very slightly with increasing operation time which was probably caused by the fact that the chlorine solubility decreased with increasing Al concentration.

Besides the main electrochemical process, the Al

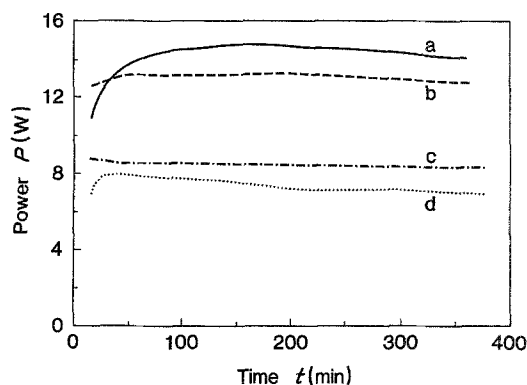
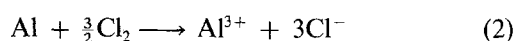
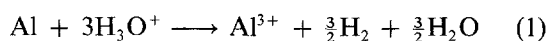

Fig. 7. Power-time curves of a module working with four different external resistors. Resistors: (a) 0.20; (b) 0.24; (c) 0.44; (d) 0.55 Ω. Electrolyte: 2 M NaCl + 3 × 10⁻⁴ M InCl₃ + 3 × 10⁻⁴ M HgCl₂; pH 2.

anodes also dissolved in the electrolyte by two parasitic reactions taking place at the aluminum electrode. First, H₂ evolution occurred as a direct reaction between the aqueous solution and the Al electrode (1) and secondly, the chlorine dissolved in the electrolyte attacked the Al electrode by direct chemical reaction (2).



These two reactions decrease the Faraday efficiency. Equation 1 expresses the H₂ evolution which depends on electrode potential, current density, pH, etc. The H₂ evolution on Al is anomalous because it increases with an increasing anodic polarization. This effect is called the negative difference effect [18]. Therefore this mechanistic consideration is of no importance for our Faradaic efficiency discussion.

The Faradaic efficiency of the whole module reached 44% at a power output of 7.4 W and 72% at a power output of 14.4 W. The maximum energy efficiency achieved with this module was 43%. The experiments showed that the H₂ evolution became more important with increasing operation time (Fig. 5). This was probably caused by small graphite particles released by the cathodes which, when in contact with the Al anodes, diminished the overpotential of the H₂ evolution at the Al electrodes. This release of carbon particles is especially severe with new electrodes and decreases when the graphite electrodes are used many times. An extensive washing is not sufficient to completely inhibit this release. Experimentally, H₂ evolution is lower in cells using old electrodes than with those using new electrodes. In a previous paper [16] it was shown that in the absence of chlorine the Faradaic efficiency was dependent on the electrolyte additives and was between 80 and 96%.

Due to the hydrogen evolution the pH is expected to increase while the cell is in operation. However it remained surprisingly stable. First, it increases up to pH 2.7–3.0 where it remains invariant over the whole operation time. Liberation of protons by the formation of monohydroxo complexes or polynuclear hydroxo complexes seems to compensate for the loss of protons by hydrogen evolution.

To improve the performance of the seven-cell module the internal resistance has to be decreased and the individual cells should not differ in cell wall thickness and electrode porosity as much as they did in our experiments. Our cells varied in power output as much as 25%. The power delivered by the module is strongly affected by the individual cell performance.

4. Conclusion

The experimental work described in this paper shows that a weakly acidic NaCl solution is an adequate electrolyte for an Al/Cl₂ battery if small amounts of In³⁺ and Hg²⁺ are added to the electrolyte. The Faradaic efficiency obtained with a module containing seven cylindrical cells depends on the power

output and reaches 72% at a power density of about 25 mW cm⁻² and a cell voltage of 1.75 V. At single-unit cells, power densities up to 55 mW cm⁻² can be reached. The maximum energy efficiency at optimal conditions reached about 43%. At lower power densities the energy and Faradaic efficiencies are smaller than at higher power densities, because the relative constant chlorine corrosion is proportionally more important at lower power output than at higher power output. Even when the coaxial cylindrical cell arrangement offers more chlorine electrode surface, the cell performance is limited by the current density of the chlorine electrode. The power output of a single cell and of a module with seven cells connected in parallel was very stable after a certain induction time. The cell performance could probably be improved if shorter chlorine electrodes were used and more homogeneous cathode materials employed. An increase in H₂ evolution was observed during the operation time of the battery. We suppose that the hydrogen production is catalyzed by small carbon particles which are deposited on the Al electrode. In a future paper we will present results of an Al/Cl₂ battery with porous titanium chlorine electrodes and plane-parallel electrode disposition.

Acknowledgement

We wish to thank the 'Nationaler Energie-Forschungs-Fonds' for supporting this work (NEFF-Projekt 217.1). We thank Dr K. Müller from the Battelle Research Centres in Geneva for helpful discussions, Mr R. Keil from our institute for sample analysis and Mr D. Wullschleger for excellent technical assistance.

References

- [1] N. Fitzpatrick and G. Scamans, *New Scientist* 17 July (1986) 34.
- [2] S. Zaromb, *J. Electrochem. Soc.* **109** (1962) 1125.
- [3] S. Zaromb, Publ. Health Serv., Publ. No. 999-AP-37 (1967) p. 255.
- [4] M. Katoh, K. Shimizu and S. Katoh, *Denki Kagaku* **38** (1970) 753.
- [5] J. Ruch, *Prog. B & S* **3** (1980) 227.
- [6] J. F. Cooper, LML Report UCRL-838881 (1980).
- [7] D. J. Levy, R. P. Hollandsworth, E. M. Gonzales and E. L. Littauer, 'Proc. 18th IECEC' (1983) Vol. 4, p. 1635.
- [8] D. M. Drazic, A. R. Despic, S. Zecevic and M. Atanackovic, *Power Sources* **7** (1978) 353.
- [9] A. R. Despic, D. M. Drazic and S. Zecevic, UCRL-TRANS-11536 (1979).
- [10] M. Ritschel and W. Vielstich, *Electrochim. Acta* **24** (1979) 885.
- [11] P. C. Symons and P. Carr, 'Proc. 8th Inter-soc. En. Conv. Eng. Conf.', No. 739010, August (1973) p. 72–77.
- [12] Energy Development Associates, Palo Alto, CA, Electric Power Res. Inst., J. Birk, Sept. 1976, EM-249.
- [13] Energy Development Associates, Palo Alto, CA, Electric Power Res. Inst., May 1980, EM-1417.
- [14] C. M. Blevins, *J. Power Sources* **7** (1981/1982) 121.
- [15] O. Haas, 'Extended Abstracts', 37th ISE Meeting, Vilnius, USSR (1986) Vol. 1, p. 210.
- [16] M. C. Reboul, Ph. Gimenez and J. J. Rameau, *Corrosion* **40** (1987) 367.
- [17] J.-F. Equey, S. Müller and O. Haas, in preparation.
- [18] D. M. Drazic and A. R. Despic, *Bull. Soc. Chim. Beograd* **48** (1983) Suppl. 5.